



MARRONWOOD

01.09.2024



MARRONWOOD

+ reilua jalopuukauppaa +

Suomen suurimmalla jalopuutukulla on hyviä uutisia!
Alensimme lähes kaikkien liimapuulevyjen hintoja.
Edelleenkin tunnuslauseemme on: "Reilua jalopuukauppaa."
Emme peri tilinhoitomaksua tai laskutuslisää, rahdit
laskutamme omakustannushinnoin.

Sisällysluettelo

■ Puulevyt täyspitkällä sauvalla	1-10
■ Puulevyt sormijatkettu	11-13
■ Jalopuu sahatavara	14-19
■ Strömfors paneelit	23
■ Sisustuspaneelit	25-26
■ Rimapaneelit	27-28
■ Akustiikka rimapaneelit	29
■ Rustic paneelit	31
■ Saunapaneelit	33-34
■ Saunalauteet	36
■ Terassilaudat ja tammiparrut	37

Juha Suninen
+358505002528

Jarmo Aalto
+358401375959

Mikko Avikainen
+358401868586

Kimmo Aaltonen
+358505183310

etunimi.sukunimi@marronwood.com



UNITED STATES

CANADA

MW

MW

UNITED STATES

MW

MW

MEXICO

North Atlantic Ocean

Pacific Ocean

VENEZUELA

COLOMBIA

PERU

BRAZIL

MW

BOLIVIA

PARAGUAY

CHILE

ARGENTINA

URUGUAY

South Atlantic Ocean

HAWAIIAN ISLANDS (U.S.)



GREENLAND
(DENMARK)

Artic Ocean

ICELAND

SWEDEN

NORWAY

FINLAND

UNITED KINGDOM

IRELAND

ESTONIA

LITHUANIA

FRANCE

CZECH REPUBLIC

POLAND

SLOVAKIA

HUNGARY

ROMANIA

BULGARIA

UKRAINE

PORTUGAL

SPAIN

MOROCCO

ALGERIA

LIBYA

EGYPT

SYRIA

IRAQ

IRAN

KAZAKHSTAN

TURKMENISTAN

UZBEKISTAN

KYRGYZSTAN

AFGHANISTAN

PAKISTAN

INDIA

WESTERN SAHARA

MAURITANIA

MALI

NIGER

GUINEA

GHANA

NIGERIA

CHAD

SUDAN

SOUTH SUDAN

ETHIOPIA

YEMEN

SOMALIA

NEPAL

SRI LANKA

GABON

CENTRAL AFRICAN REPUBLIC

UGANDA

KENYA

ANGOLA

DEMOCRATIC REPUBLIC OF THE CONGO

TANZANIA

NAMIBIA

ZAMBIA

MOZAMBIQUE

BOTSWANA

ZIMBABWE

SOUTH AFRICA

MADAGASCAR

Atlantic Ocean

Indian Ocean

Atlantic Ocean

Puulevyt Täyspitkällä Sauvalla

Puulaji	Laatu	Paksuus mm	Leveys mm	Pituus mm
Koivu	A/A	12	620	Eri pit.
Koivu	A/A	15	620	Eri pit.
Koivu	A/B	20	620	900
Koivu	A/B	20	620	1000
Koivu	A/B	20	620	1100
Koivu	A/B	20	620	1200
Koivu	A/B	20	620	1300
Koivu	A/B	20	620	1400
Koivu	A/B	20	620	1500
Koivu	A/B	20	620	1600
Koivu	A/B	20	620	1700
Koivu	A/B	20	620	1800
Koivu	A/B	20	620	1900
Koivu	A/B	20	620	2000
Koivu	A/B	20	620	2100
Koivu	A/B	20	620	2200
Koivu	A/B	20	620	2300
Koivu	A/B	20	620	2400
Koivu	A/B	20	620	2500
Koivu	A/B	20	620	2600
Koivu	A/B	20	620	2700
Koivu	A/B	20	620	2800
Koivu	A/B	20	620	2900
Koivu	A/B	20	620	3000
Koivu	A/B	20	620	3100
Koivu	A/B	20	620	3200
Koivu	A/B	20	620	3300
Koivu	A/B	20	1050	1800
Koivu	A/B	20	1050	1900
Koivu	A/B	20	1050	2000
Koivu	A/B	20	1050	2100
Koivu	A/B	20	1050	2200
Koivu	A/B	20	1050	2300
Koivu	A/B	20	1050	2400
Koivu	A/B	20	1050	2500
Koivu	A/B	20	1050	2600
Koivu	A/B	20	1050	2700
Koivu	A/B	20	1050	2800
Koivu	A/B	20	1050	2900
Koivu	A/B	20	1050	3000
Koivu	A/B	20	1050	3100
Koivu	A/B	20	1050	3200
Koivu	A/B	20	1050	3300



Puulevyt Täyspitkällä Sauvalla

Puulaji	Laatu	Paksuus mm	Leveys mm	Pituus mm
Koivu	A/B	30	620	1500
Koivu	A/B	30	620	1600
Koivu	A/B	30	620	1700
Koivu	A/B	30	620	1800
Koivu	A/B	30	620	1900
Koivu	A/B	30	620	2000
Koivu	A/B	30	620	2100
Koivu	A/B	30	620	2200
Koivu	A/B	30	620	2300
Koivu	A/B	30	620	2400
Koivu	A/B	30	620	2500
Koivu	A/B	30	620	2700
Koivu	A/B	30	620	2800
Koivu	A/B	30	620	2900
Koivu	A/B	30	620	3000
Koivu	A/B	30	620	3100
Koivu	A/B	30	620	3200
Koivu	A/B	30	620	3300
Koivu	A/B	30	1050	1800
Koivu	A/B	30	1050	1900
Koivu	A/B	30	1050	2000
Koivu	A/B	30	1050	2100
Koivu	A/B	30	1050	2200
Koivu	A/B	30	1050	2300
Koivu	A/B	30	1050	2400
Koivu	A/B	30	1050	2500
Koivu	A/B	30	1050	2600
Koivu	A/B	30	1050	2700
Koivu	A/B	30	1050	2800
Koivu	A/B	30	1050	2900
Koivu	A/B	30	1050	3000
Koivu	A/B	30	1050	3100
Koivu	A/B	30	1050	3200
Koivu	A/B	30	1050	3300
Koivu	A/B	40	620	1800
Koivu	A/B	40	620	1900
Koivu	A/B	40	620	2000
Koivu	A/B	40	620	2100
Koivu	A/B	40	620	2200
Koivu	A/B	40	620	2300
Koivu	A/B	40	620	2400
Koivu	A/B	40	620	2500
Koivu	A/B	40	620	2600
Koivu	A/B	40	620	2700
Koivu	A/B	40	620	2800
Koivu	A/B	40	620	2900
Koivu	A/B	40	620	3000
Koivu	A/B	40	620	3100
Koivu	A/B	40	620	3200
Koivu	A/B	40	620	3300

Puulevyt Täyspitkällä Sauvalla

Puulaji	Laatu	Paksuus mm	Leveys mm	Pituus mm
Koivu	A/B	40	1050	1800
Koivu	A/B	40	1050	1900
Koivu	A/B	40	1050	2000
Koivu	A/B	40	1050	2100
Koivu	A/B	40	1050	2200
Koivu	A/B	40	1050	2300
Koivu	A/B	40	1050	2400
Koivu	A/B	40	1050	2500
Koivu	A/B	40	1050	2600
Koivu	A/B	40	1050	2700
Koivu	A/B	40	1050	2800
Koivu	A/B	40	1050	2900
Koivu	A/B	40	1050	3000
Koivu	A/B	40	1050	3100
Koivu	A/B	40	1050	3200
Koivu	A/B	40	1050	3300
Koivu	A/B	50	650	Eri.pit
Koivu	A/B	50	1050	Eri.pit
Koivu	A/B	40	650	900
Koivu	A/B	40	650	1000
Koivu	A/B	40	650	1100
Koivu	A/B	40	650	1200
Koivu	A/B	40	650	1300
Koivu	A/B	40	650	1400
Koivu	A/B	40	650	1500
Koivu	A/A	40	650	900
Koivu	A/A	40	650	1000
Koivu	A/A	40	650	1100
Koivu	A/A	40	650	1200
Koivu	A/A	40	650	1300
Koivu	A/A	40	650	1400
Koivu	A/A	40	650	1500



Mikko Avikainen
0401868586

Juha Suninen
0505002528

Jarmo Aalto
0401375959

Puulevyt Täyspitkällä Sauvalla

Puulaji	Laatu	Paksuus mm	Leveys mm	Pituus mm	€/m ²
Saarni	A/B	20	650	900	
Saarni	A/B	20	650	1000	
Saarni	A/B	20	650	1100	
Saarni	A/B	20	650	1200	
Saarni	A/B	20	650	1300	
Saarni	A/B	20	650	1400	
Saarni	A/B	20	650	1500	
Saarni	A/B	20	650	1600	
Saarni	A/B	20	650	1700	
Saarni	A/B	20	650	1800	
Saarni	A/B	20	650	1900	
Saarni	A/B	20	650	2000	
Saarni	A/B	20	650	2100	
Saarni	A/B	20	650	2200	
Saarni	A/B	20	650	2300	
Saarni	A/B	20	650	2400	
Saarni	A/B	20	650	2500	
Saarni	A/B	20	650	2600	
Saarni	A/B	20	650	2700	
Saarni	A/B	20	650	2800	
Saarni	A/B	20	650	2900	
Saarni	A/B	20	650	3000	
Saarni	A/B	20	650	3100	



Puulevyt Täyspitkällä Sauvalla

Puulaji	Laatu	Paksuus mm	Leveys mm	Pituus mm
Saarni	A/B	30	650	900
Saarni	A/B	30	650	1000
Saarni	A/B	30	650	1100
Saarni	A/B	30	650	1200
Saarni	A/B	30	650	1300
Saarni	A/B	30	650	1400
Saarni	A/B	30	650	1500
Saarni	A/B	30	650	1600
Saarni	A/B	30	650	1700
Saarni	A/B	30	650	1800
Saarni	A/B	30	650	1900
Saarni	A/B	30	650	2000
Saarni	A/B	30	650	2100
Saarni	A/B	30	650	2200
Saarni	A/B	30	650	2300
Saarni	A/B	30	650	2400
Saarni	A/B	30	650	2500
Saarni	A/B	30	650	2600
Saarni	A/B	30	650	2700
Saarni	A/B	30	650	2800
Saarni	A/B	30	650	2900
Saarni	A/B	30	650	3000
Saarni	A/B	30	650	3100
Saarni	A/B	30	1050	1800
Saarni	A/B	30	1050	1900
Saarni	A/B	30	1050	2000
Saarni	A/B	30	1050	2100
Saarni	A/B	30	1050	2200
Saarni	A/B	30	1050	2300
Saarni	A/B	30	1050	2400
Saarni	A/B	30	1050	2500
Saarni	A/B	30	1050	2600
Saarni	A/B	30	1050	2700
Saarni	A/B	30	1050	2800
Saarni	A/B	30	1050	2900
Saarni	A/B	30	1050	3000



Puulevyt Täyspitkällä Sauvalla

Puulaji	Laatu	Paksuus mm	Leveys mm	Pituus mm
Saarni	A/B	40	650	900
Saarni	A/B	40	650	1000
Saarni	A/B	40	650	1100
Saarni	A/B	40	650	1200
Saarni	A/B	40	650	1300
Saarni	A/B	40	650	1400
Saarni	A/B	40	650	1500
Saarni	A/B	40	650	1600
Saarni	A/B	40	650	1700
Saarni	A/B	40	650	1800
Saarni	A/B	40	650	1900
Saarni	A/B	40	650	2000
Saarni	A/B	40	650	2100
Saarni	A/B	40	650	2200
Saarni	A/B	40	650	2300
Saarni	A/B	40	650	2400
Saarni	A/B	40	650	2500
Saarni	A/B	40	650	2600
Saarni	A/B	40	650	2700
Saarni	A/B	40	650	2800
Saarni	A/B	40	650	2900
Saarni	A/B	40	650	3000
Saarni	A/B	40	650	3100
Saarni	A/B	40	650	3200
Saarni	A/B	40	650	3300
Saarni	A/B	40	1050	1800
Saarni	A/B	40	1050	1900
Saarni	A/B	40	1050	2000
Saarni	A/B	40	1050	2100
Saarni	A/B	40	1050	2200
Saarni	A/B	40	1050	2300
Saarni	A/B	40	1050	2400
Saarni	A/B	40	1050	2500
Saarni	A/B	40	1050	2600
Saarni	A/B	40	1050	2700
Saarni	A/B	40	1050	2800
Saarni	A/B	40	1050	2900
Saarni	A/B	40	1050	3000



Mikko Avikainen
0401868586

Juha Suninen
0505002528

Jarmo Aalto
0401375959

Puulevyt Täyspitkällä Sauvalla

Puulaji	Laatu	Paksuus mm	Leveys mm	Pituus mm
Tammi VG	A/A	10	650	Eri pit.
Tammi VG	A/A	12	650	Eri pit.
Tammi VG	A/A	15	650	Eri pit.
Tammi VG	A/B	20	650	900-1900
Tammi VG	A/B	20	650	2000-2500
Tammi VG	A/B	20	650	2600-2900
Tammi VG	A/B	20	650	3000-3400
Tammi VG	A/B	20	650	3500+
Tammi VG	A/B	25	650	900-1900
Tammi VG	A/B	25	650	2000-2500
Tammi VG	A/B	25	650	2600-2900
Tammi VG	A/B	25	650	3000-3400
Tammi VG	A/B	25	650	3500+
Tammi VG	A/B	30	650	900-1900
Tammi VG	A/B	30	650	2000-2500
Tammi VG	A/B	30	650	2600-2900
Tammi VG	A/B	30	650	3000-3400
Tammi VG	A/B	30	650	3500+
Tammi VG	A/B	30	1050	900-1900
Tammi VG	A/B	30	1050	2000-2500
Tammi VG	A/B	30	1050	2600-2900
Tammi VG	A/B	30	1050	3000-3400
Tammi VG	A/B	30	1050	3500+
Tammi VG	A/B	40	650	900-1900
Tammi VG	A/B	40	650	2000-2500
Tammi VG	A/B	40	650	2600-2900
Tammi VG	A/B	40	650	3000-3400
Tammi VG	A/B	40	650	3500+
Tammi VG	A/B	40	1050	900-1900
Tammi VG	A/B	40	1050	2000-2500
Tammi VG	A/B	40	1050	2600-2900
Tammi VG	A/B	40	1050	3000-3400
Tammi VG	A/B	40	1050	3500+
Tammi VG	A/B	50	650	900-1900
Tammi VG	A/B	50	650	2000-2500
Tammi VG	A/B	50	650	2600-2900
Tammi VG	A/B	50	650	3000-3400
Tammi VG	A/B	50	650	3500+
Tammi VG	A/B	50	1050	900-1900
Tammi VG	A/B	50	1050	2000-2500
Tammi VG	A/B	50	1050	2600-2900
Tammi VG	A/B	50	1050	3000-3400
Tammi VG	A/B	50	1050	3500+

Puulevyt Täyspitkällä Sauvalla

Puulaji	Laatu	Paksuus mm	Leveys mm	Pituus mm
A-puolen oksaton				
Mänty VG	A/B	10	650	Eri pit.
Mänty VG	A/B	15	1020	Eri pit.
Mänty VG	A/B	17	1020	Eri pit.
Mänty VG	A/B	20	1020	Eri pit.
Mänty VG	A/B	30	1020	Eri pit.
Mänty VG	A/B	40	1020	Eri pit.
Mänty VG	A/B	45	1020	Eri pit.
Mänty VG	A/B	50	1020	Eri pit.

VG eli Vertical Grain ja myös
"Very Good"

Suorasyinen rakenne takaa
hillityn yleisilmeen



Puulevyt Täyspitkällä Sauvalla

Puulaji	Laatu	Paksuus mm	Leveys mm	Pituus mm
Tammi	A/B	20	650	900-1900
Tammi	A/B	20	650	2000-2500
Tammi	A/B	20	650	2600-2900
Tammi	A/B	20	650	3000-3400
Tammi	A/B	20	650	3500+
Tammi	A/B	20	1050	900-1900
Tammi	A/B	20	1050	2000-2500
Tammi	A/B	20	1050	2600-2900
Tammi	A/B	20	1050	3000-3400
Tammi	A/B	20	1050	3500+
Tammi	B/B	20	650	900-1900
Tammi	B/B	20	650	2000-2500
Tammi	B/B	20	650	2600-2900
Tammi	B/B	20	650	3000-3400
Tammi	B/B	20	650	3500+
Tammi	A/B	20	1220	1600-1900
Tammi	A/B	20	1220	2000-2500
Tammi	A/B	20	1220	2600-2900
Tammi	A/B	20	1220	3000-3400
Tammi	A/B	20	1220	3500+
Tammi	A/B	25	650	900-1900
Tammi	A/B	25	650	2000-2500
Tammi	A/B	25	650	2600-2900
Tammi	A/B	25	650	3000-3400
Tammi	A/B	25	650	3500+



Puulevyt Täyspitkällä Sauvalla

Puulaji	Laatu	Paksuus mm	Leveys mm	Pituus mm
Tammi	A/B	30	650	900-1900
Tammi	A/B	30	650	2000-2500
Tammi	A/B	30	650	2600-2900
Tammi	A/B	30	650	3000-3400
Tammi	A/B	30	650	3500+
Tammi	A/B	30	1220	1600-1900
Tammi	A/B	30	1220	2000-2500
Tammi	A/B	30	1220	2600-2900
Tammi	A/B	30	1220	3000+
Tammi	A/B	40	650	900-1200
Tammi	A/B	40	650	1300-1900
Tammi	A/B	40	650	2000-2500
Tammi	A/B	40	650	2600-2900
Tammi	A/B	40	650	3000+
Tammi	A/B	40	1220	1600-1900
Tammi	A/B	40	1220	2000-2500
Tammi	A/B	40	1220	2600-2900
Tammi	A/B	40	1220	3000+



Puulevyt Sormijatkettu

Puulaji	Laatu	Paksuus mm	Leveys mm	Pituus mm
Koivu	A/B	18	650	3250
Koivu	A/B	18	740	2900
Koivu	A/B	18	900	3000
Koivu	A/B	18	1220	3000
Koivu	A/A	18	1220	3000
Koivu	A/B	20	620	3000
Koivu	A/A	20	700	3550
Koivu	A/B	20	810	2470
Koivu	A/B	20	840	3750
Koivu	A/B	20	930	3250
Koivu	A/B	20	1050	4250
Koivu	A/B	26	1220	3440
Koivu	A/B	30	620	3000
Koivu	A/B	30	620	3500
Koivu	A/B	30	620	4200
Koivu	A/B	30	750	4200
Koivu	A/B	30	920	2650
Koivu	A/B	30	950	4200
Koivu	A/B	30	1050	3300
Koivu	A/B	30	1220	3000
Koivu	A/B	40	620	3000
Koivu	A/B	40	620	3500
Koivu	A/B	40	620	4000
Koivu	A/B	40	620	4200
Koivu	A/B	40	1050	3050
Koivu	A/B	40	650	5000
Koivu	A/B	80	80	5000



Puulevyt Sormijatkettu

Puulaji	Laatu	Paksuus mm	Leveys mm	Pituus mm
Mänty oksaton	A/A	20	1020	3000
Mänty oksaton	A/A	25	1020	3000
Mänty oksaton	A/A	30	1020	3000
Mänty oksaton	A/A	40	310	5000
Mänty oksaton	A/A	40	650	5000
Mänty oksaton	A/A	40	1020	3000
Mänty oksaton	A/A	40	1020	5000
Mänty oksaton	A/A	82	82	5000
Mänty hiomaton	A/A	42	540	2500
Mänty hiomaton	A/A	45	150	4200
Mänty hiomaton	A/A	45	175	4200
Mänty hiomaton	A/A	46	190	4500
Mänty hiomaton	A/A	46	540	2500
Mänty hiomaton	A/A	46	540	3000
Mänty hiomaton	A/A	46	540	3300
Mänty hiomaton	A/A	56	190	4500
Mänty hiomaton	A/A	58	540	2500
Mänty hiomaton	A/A	58	540	3300
Mänty hiomaton	A/A	48	98	2500
Mänty hiomaton	A/A	57	94	2500
Mänty hiomaton	Oksalaatu	42	1220	3000
Saarni	A/B	20	620	3000
Saarni	A/B	20	1050	4250
Saarni	A/B	30	620	3000
Saarni	A/B	30	620	3500
Saarni	A/B	30	620	4200
Saarni	A/B	30	1050	3650
Saarni	A/B	40	650	4000
Saarni	B/C	41	620	4000



Puulevyt Sormijatkettu

Puulaji	Laatu	Paksuus mm	Leveys mm	Pituus mm
Tammi	A/B	20	620	3000
Tammi	A/B	20	620	4250
Tammi	A/B	20	1050	4250
Tammi	A/B	30	620	3000
Tammi	A/B	30	620	3500
Tammi	A/B	30	620	4200
Tammi	A/B	30	760	4567
Tammi	A/B	30	920	4100
Tammi	A/B	30	1050	3050
Tammi	A/B	30	1050	4250
Tammi	A/B	40	620	3000
Tammi	A/B	40	620	3500
Tammi	A/B	40	650	4000
Tammi	B/C	40	650	4000
Tammi	A/B	40	650	4250
Tammi	A/B	40,5	650	5000
Tammi	A/B	40	720	3550
Tammi	A/B	40	920	4250
Tammi	A/B	40	1050	2550
Tammi	A/B	40	1050	3050
Savutammi	A/B	40	650	4000
Kirsikka (EU)	A/B	30	620	4200
Teak, aito	A/B	20	910	3000
Wenge	A/B	40	620	4000



Jalopuu Sahatavara

Puulaji	Laatu	Paksuus mm	Leveys mm	Pituus mm
Azobe	FAS	52	Eri lev.	Eri pit.
Douglas kuusi	FAS	54	Stön.	Eri pit.
Iroko	FAS	26	Eri lev.	Eri pit.
Iroko	FAS	52	Eri lev.	Eri pit.
Jalava	Prime	26	Eri lev.	Eri pit.
Jalava	Prime	52	Eri lev.	Eri pit.
Kirsikka	Prime	26	Eri lev.	Eri pit.
Kirsikka	Prime	40	Eri lev.	Eri pit.
Kirsikka	Prime	52	Eri lev.	Eri pit.



Jalopuu Sahatavara

Puulaji	Laatu	Paksuus mm	Leveys mm	Pituus mm
Koivu, särmätty	A3/A4	25	75	Eri pit.
Koivu, särmätty	A3/A4	25	100	Eri pit.
Koivu, särmätty	A3/A4	32	100	Eri pit.
Koivu, särmätty	A3/A4	40	75	Eri pit.
Koivu, särmätty	A3/A4	40	100	Eri pit.
Koivu, särmätty	A3/A4	50	100	Eri pit.
Koivu, särmätty	A3/A4	50	125	Eri pit.
Koivu	AB	50	Stön.	Eri pit.
Koivu	AB	65	Stön.	Eri pit.
Koivu	BC	75	Stön.	Eri pit.



Puulaji	Laatu	Paksuus mm	Leveys mm	Pituus mm
Sapelimahonki	FAS	26	Eri lev.	Eri pit.
Sapelimahonki	FAS	52	Eri lev.	Eri pit.
Sapelimahonki	FAS	65	Eri lev.	Eri pit.
Khayamahonki	FAS	26	Eri lev.	Eri pit.
Khayamahonki	FAS	33	Eri lev.	Eri pit.
Khayamahonki	FAS	52	Eri lev.	Eri pit.
Mänty	US I-II	25	100	Eri pit.
Mänty	US I-II	25	125	Eri pit.
Mänty	US I-II	25	150	Eri pit.
Mänty (FIN)	Stammw.	52	Eri lev.	Eri pit.
Poppeli	Prime	26	Eri lev.	Eri pit.
Punahonka	Stön.	70	Eri lev.	Eri pit.
Punatammi	Vaalea	26	Eri lev.	Eri pit.
Punatammi	Prime	26	Eri lev.	Eri pit.
Punatammi	Prime	32	Eri lev.	Eri pit.
Punatammi	Prime	52	Eri lev.	Eri pit.
Pyökki	Superior	26(23,8)	Eri lev.	2450
Pyökki	Superior	26(23,8)	Eri lev.	3050
Pyökki	Superior	32(29,5)	Eri lev.	2450
Pyökki	Superior	32(29,5)	Eri lev.	3050
Pyökki	Superior	38(36,0)	Eri lev.	3050
Pyökki	Superior	46(43,0)	Eri lev.	2450
Pyökki	Superior	52(48,5)	Eri lev.	2450
Pyökki	Superior	52(48,5)	Eri lev.	3050



Jalopuu Sahatavara

Puulaji	Laatu	Paksuus mm	Leveys mm	Pituus mm
Pähkinä	Prime	26	Eri lev.	Eri pit.
Pähkinä	Prime	40	Eri lev.	Eri pit.
Pähkinä	Prime	52	Eri lev.	Eri pit.
Saarni (EU)	A	27	100	2200-3100
Saarni (EU)	A	27	115	2200-3100
Saarni (EU)	A	27	140	2200-3100
Saarni (EU)	A	27	180	2200-3100
Saarni (EU)	A	27	210	2200-3100
Saarni (EU)	A	34	70	2200-3100
Saarni (EU)	A	34	100	2200-3100
Saarni (EU)	A	34	115	2200-3100
Saarni (EU)	A	34	123	2200-3100
Saarni (EU)	A	34	140	2200-3100
Saarni (EU)	A	34	180	2200-3100
Saarni (EU)	A	34	210	2200-3100
Saarni (EU)	A	44	100	2200-3100
Saarni (EU)	A	44	160	2200-3100
Saarni (EU)	A	44	210	2200-3100
Saarni (EU)	A	52	52	2200-3100
Saarni (EU)	A	52	80	2200-3100
Saarni (EU)	A	52	110	2200-3100
Saarni (EU)	A	52	126	2200-3100
Saarni (EU)	A	52	138	2200-3100
Saarni (EU)	A	52	159	2200-3100
Saarni (EU)	A	52	170	2200-3100
Saarni (EU)	A	52	182	2200-3100
Saarni (EU)	A	52	215	2200-3100
Saarni (USA)	Prime	26	Eri lev.	Eri Pit.
Saarni (USA)	Prime	32	Eri lev.	Eri Pit.
Saarni (USA)	Prime	40	Eri lev.	Eri Pit.
Saarni (USA)	Prime	52	Eri lev.	Eri Pit.
Saarni (USA)	Prime	65	Eri lev.	Eri Pit.



Puulaji	Laatu	Paksuus mm	Leveys mm	Pituus mm
Tervaleppä	A	19	100	1500
Tervaleppä	A	19	100	1800
Tervaleppä	A	19	135	2400
Tervaleppä	A	32	100	1500
Vaahtera	Prime	26	Eri lev.	Eri pit.
Vaahtera	Prime	52	Eri lev.	Eri pit.



Jalopuu Sahatavara

Puulaji	Laatu	Paksuus mm	Leveys mm	Pituus mm
Valkotammi (USA)	Prime	26	78	Eri pit.
Valkotammi (USA)	Prime	26	105	Eri pit.
Valkotammi (USA)	Prime	26	125	Eri pit.
Valkotammi (USA)	Prime	26	135	Eri pit.
Särmäämme myös mittojen mukaan. Pyydä tarjous! Maailman paras tuuman tammi				
Valkotammi (USA)	Super Prime	26	Eri lev.	Eri pit.
Valkotammi (USA)	Prime	26	Eri lev.	2150
Valkotammi (USA)	Prime	26	Eri lev.	2450
Valkotammi (USA)	Prime	26	Eri lev.	2750-3050
Valkotammi (USA)	Prime	26	Eri lev.	3360-3660
Valkotammi (USA)	Prime	26	Eri lev.	3960-4260
Valkotammi (USA)	Prime	32	Eri lev.	2150-2450
Valkotammi (USA)	Prime	32	Eri lev.	2750-3050
Valkotammi (USA)	Prime	32	Eri lev.	3360-3660
Valkotammi (USA)	Prime	40	Eri lev.	2150-2450
Valkotammi (USA)	Prime	40	Eri lev.	2750-3050
Valkotammi (USA)	Prime	40	Eri lev.	3360-3660
Valkotammi (USA)	Prime	52	Eri lev.	2150-2450
Valkotammi (USA)	Prime	52	Eri lev.	2750-3050
Valkotammi (USA)	Prime	52	Eri lev.	3360-3660
Valkotammi (USA)	Prime	52	Eri lev.	3960-4260
Tammi (EU)	Rustic	54	Stön.	Eri pit.
Tammi (EU)	Rustic	54	Stön. 350+	Eri pit.
Tammi (EU)	Rustic	54	Särmätty	Eri pit.
Tammi (EU)	Rustic	65	Stön.	Eri pit.
Tammi (EU)	Rustic	65	Stön. 350+	Eri pit.
Särmätty				
Tammi (EU)	QFA/1BX	27	Eri lev.	Eri pit.
Tammi (EU)	QFA/1BX	34	Eri lev.	Eri pit.
Tammi (EU)	Super Prime	54	Eri lev.	Eri pit.

Maailman paras kahden tuuman tammi





MARRONWOOD

MARRONWOOD

Marron Wood Oy tarjoaa Suomen suurimman valikoiman jalopuisia sisustus- ja saunapaneeleita lukuisiin eri käyttökohteisiin. Tuotteet valmistetaan tehtaallamme Strömforsin ruukissa omista raaka-aineistamme.

Tuotteet ovat saatavilla puuvalmiina tai pintakäsiteltynä, meidän tuoteprofilin tai asiakkaan valitseman profilin mukaisesti.

Valikoimastamme löydät sisäpuolen sisustuspaneelit, rimapaneelit, akustiset rimapaneelit, Rustic paneelit sekä saunapaneelit ja lauteet.



Tammi



Mahonki



Oliivisaarni



Saarni

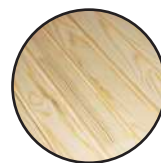

Mänty



Iroko



Koivu



Vaahtera



Jalava



Thermo
Royal

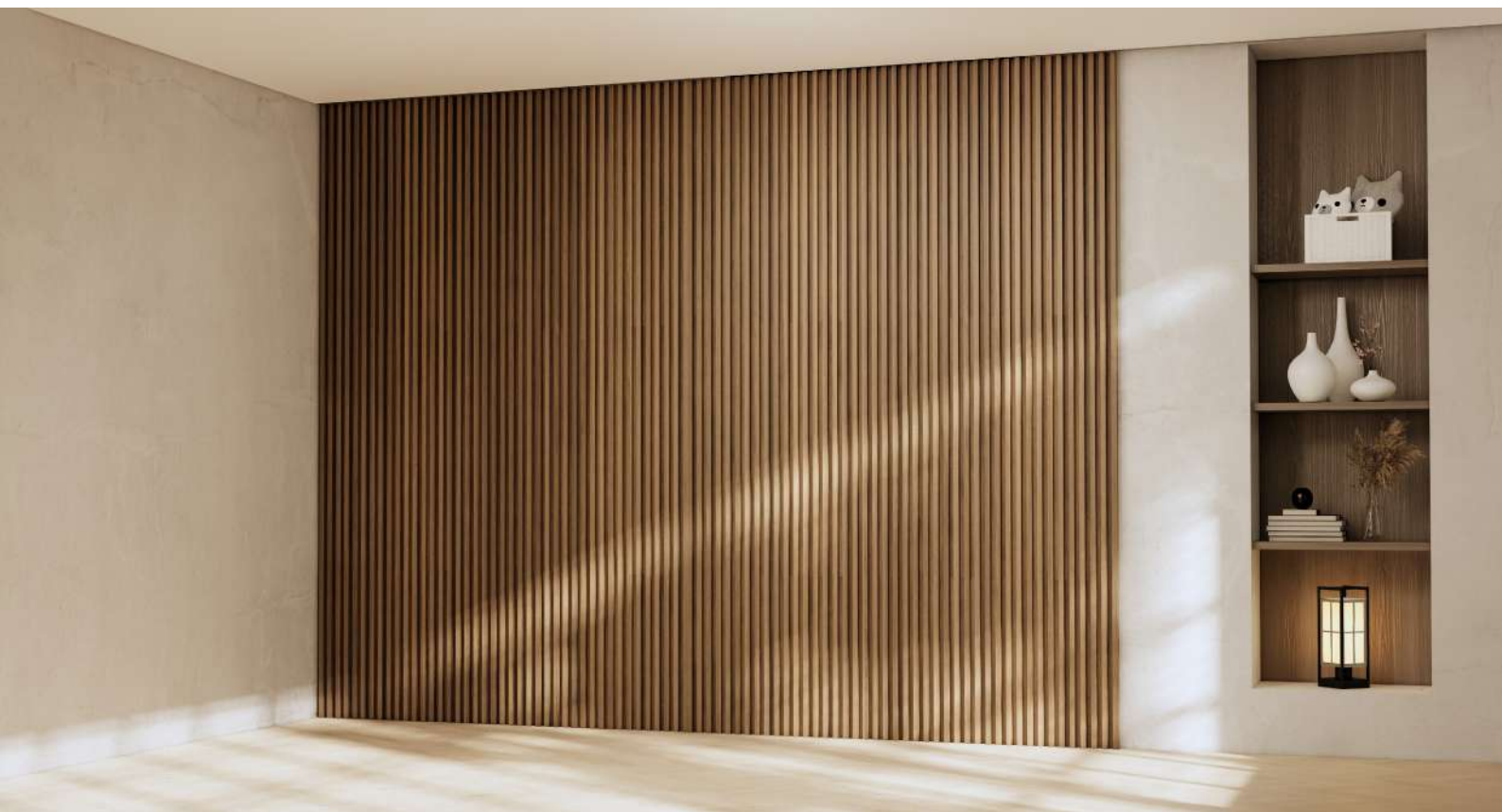

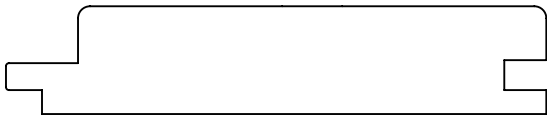

Holvi

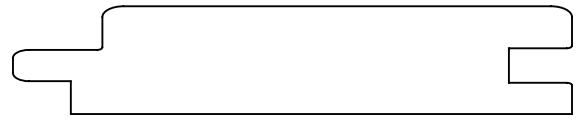

Aava

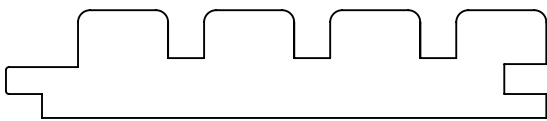

Väre

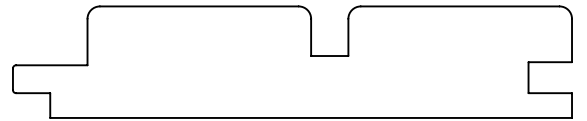

Hohto

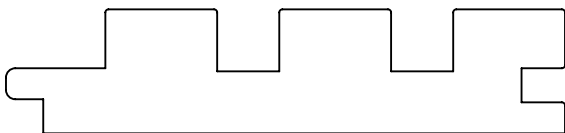

Aro/Halla

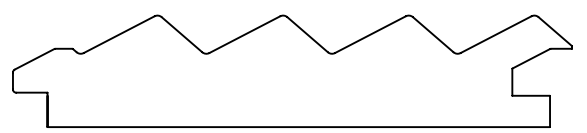

Aalto

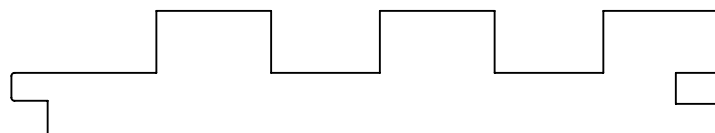

Loisto

Strömfors paneelit

Puulaji	Laatu	Profiili	Paksuus mm	Leveys mm	Pituus mm
Strömfors paneelit					
Douglaskuusi	Select		11	200	1800-4000
Douglaskuusi	Select		11	260	1800-4000
Douglaskuusi	Natur		11	200	1800-4000
Douglaskuusi	Natur		11	260	1800-4000
Saarni	Select		11	200	1800-3000
Saarni	Select		11	260	1800-3000
Oliivisaarni	Natur		11	200	1800-3000
Oliivisaarni	Natur		11	260	1800-3000
Tammi	Select		11	200	1800-3000
Tammi	Select		11	260	1800-3000
Tammi	Select		11	300	1800-3000
Tammi	Natur		11	200	1800-3000
Tammi	Natur		11	260	1800-3000
Tammi	Natur		11	300	1800-3000
Tammi	Rustic		11	200	1800-3000
Tammi	Rustic		11	260	1800-3000
Tammi	Rustic		11	300	1800-3000
Kirsikka	Select		11	180	1800-3000
Mahonki	Select		11	200	1800-4000
Mahonki	Select		11	260	1800-4000
Mahonki	Select		11	300	1800-4000
Iroko	Select		11	200	1800-4000
Iroko	Select		11	260	1800-4000
Iroko	Select		11	300	1800-4000

Strömfors -paneelit toimitetaan tilauksesta, toimitusaika 2-3 viikkoa

Profiili Nollasauma

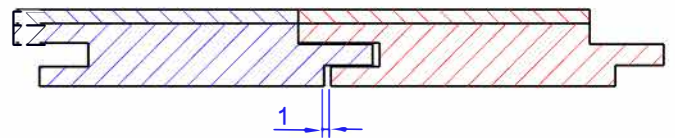
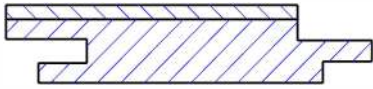

Tuotteen rakenne on
9 mm koivuvaneri + 2 mm jalopuupinta

Profiili STV

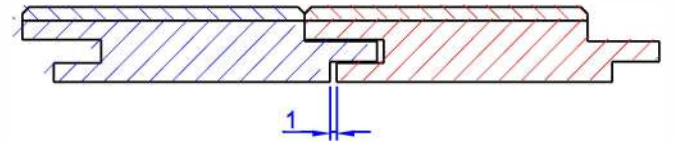
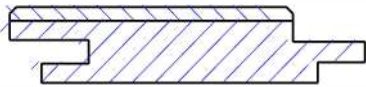

Sisustuspaneelit

Puulaji	Laatu	Profiili	Paksuus mm	Leveys mm	Pituus mm
Holvi paneelit					
Tammi	A	Holvi	20	90	1800-3000
Tammi	A	Holvi	20	140	1800-3000
Saarni	A	Holvi	20	90	1800-3000
Saarni	A	Holvi	20	140	1800-3000
Oliivisaarni	A	Holvi	20	90	1800-3000
Oliivisaarni	A	Holvi	20	140	1800-3000
Koivu	A	Holvi	20	90	1800-3000
Koivu	A	Holvi	20	140	1800-3000
Vaahtera	A	Holvi	20	90	1800-3000
Vaahtera	A	Holvi	20	140	1800-3000
Mahonki	A	Holvi	20	90	1800-3000
Mahonki	A	Holvi	20	140	1800-3000
Kirsikka	A	Holvi	20	90	1800-3000
Kirsikka	A	Holvi	20	140	1800-3000
Thermo Royal	A	Holvi	20	90	1800-4000
Thermo Royal	A	Holvi	20	140	1800-4000
Douglaskuusi	A	Holvi	20	90	1800-4000
Douglaskuusi	A	Holvi	20	140	1800-4000
Iroko	A	Holvi	20	90	1800-4000
Iroko	A	Holvi	20	140	1800-4000
Erikoismänty	A	Holvi	20	90	1800-3000
Erikoismänty	A	Holvi	20	140	1800-3000
Lämp.käsit.mänty	A	Holvi	20	90	1800-3000
Lämp.käsit.mänty	A	Holvi	20	140	1800-3000
Eukalyptus	A	Holvi	20	90	1800-4000
Eukalyptus	A	Holvi	20	140	1800-4000

Holvi -paneelit toimitetaan tilauksesta, toimitusaika 2-3 viikkoa

Sisustuspaneelit

Puulaji	Laatu	Profiili	Paksuus mm	Leveys mm	Pituus mm
Aava paneelit					
Tammi	A	Aava	20	90	1800-3000
Tammi	A	Aava	20	140	1800-3000
Saarni	A	Aava	20	90	1800-3000
Saarni	A	Aava	20	140	1800-3000
Oliivisaarni	A	Aava	20	90	1800-3000
Oliivisaarni	A	Aava	20	140	1800-3000
Koivu	A	Aava	20	90	1800-3000
Koivu	A	Aava	20	140	1800-3000
Vaahtera	A	Aava	20	90	1800-3000
Vaahtera	A	Aava	20	140	1800-3000
Mahonki	A	Aava	20	90	1800-4200
Mahonki	A	Aava	20	140	1800-4200
Kirsikka	A	Aava	20	90	1800-3000
Kirsikka	A	Aava	20	140	1800-3000
Thermo Royal	A	Aava	20	90	1800-4000
Thermo Royal	A	Aava	20	140	1800-4000
Douglaskuusi	A	Aava	20	90	1800-4000
Douglaskuusi	A	Aava	20	140	1800-4000
Iroko	A	Aava	20	90	1800-4000
Iroko	A	Aava	20	140	1800-4000
Erikoismänty	A	Aava	20	90	1800-3000
Erikoismänty	A	Aava	20	140	1800-3000
Lämp.käsit.mänty	A	Aava	20	90	1800-3000
Lämp.käsit.mänty	A	Aava	20	140	1800-3000
Eukalyptus	A	Aava	20	90	1800-4000
Eukalyptus	A	Aava	20	140	1800-4000

Aava -paneelit toimitetaan tilauksesta, toimitusaika 2-3 viikkoa

Rimapaneelit

Puulaji	Laatu	Profiili	Paksuus mm	Leveys mm	Pituus mm
Tammi	A/B	Hohto	20	90 (84)	1800-3000
Tammi	A/B	Loisto	20	117 (111)	1800-3000
Tammi	A/B	Aalto	20	90 (84)	1800-3000
Tammi	A/B	Väre	20	90 (84)	1800-3000
Tammi	A/B	Valve	20	90 (84)	1800-3000
Saarni	A/B	Hohto	20	90 (84)	1800-3000
Saarni	A/B	Loisto	20	117 (111)	1800-3000
Saarni	A/B	Aalto	20	90 (84)	1800-3000
Saarni	A/B	Väre	20	90 (84)	1800-3000
Saarni	A/B	Valve	20	90 (84)	1800-3000
Oliivisaarni	A/B	Hohto	20	90 (84)	1800-3000
Oliivisaarni	A/B	Loisto	20	117 (111)	1800-3000
Oliivisaarni	A/B	Aalto	20	90 (84)	1800-3000
Oliivisaarni	A/B	Väre	20	90 (84)	1800-3000
Oliivisaarni	A/B	Valve	20	90 (84)	1800-3000
Koivu	A/B	Hohto	20	90 (84)	1800-3000
Koivu	A/B	Loisto	20	117 (111)	1800-3000
Koivu	A/B	Aalto	20	90 (84)	1800-3000
Koivu	A/B	Väre	20	90 (84)	1800-3000
Koivu	A/B	Valve	20	90 (84)	1800-3000
Mahonki	A/B	Hohto	20	90 (84)	1800-4200
Mahonki	A/B	Loisto	20	117 (111)	1800-4200
Mahonki	A/B	Aalto	20	90 (84)	1800-4200
Mahonki	A/B	Väre	20	90 (84)	1800-4200
Mahonki	A/B	Valve	20	90 (84)	1800-4200
Jalava	A/B	Hohto	20	90 (84)	1800-4200
Jalava	A/B	Loisto	20	117 (111)	1800-4200
Jalava	A/B	Aalto	20	90 (84)	1800-4200
Jalava	A/B	Väre	20	90 (84)	1800-4200
Jalava	A/B	Valve	20	90 (84)	1800-4200
Thermo Royal™	A/B	Hohto	20	90 (84)	1800-4200
Thermo Royal™	A/B	Loisto	20	117 (111)	1800-4200
Thermo Royal™	A/B	Aalto	20	90 (84)	1800-4200
Thermo Royal™	A/B	Väre	20	90 (84)	1800-4200
Thermo Royal™	A/B	Valve	20	90 (84)	1800-4200
Kirsikka	A/B	Hohto	20	90 (84)	1800-4200
Kirsikka	A/B	Loisto	20	117 (111)	1800-4200
Kirsikka	A/B	Aalto	20	90 (84)	1800-4200
Kirsikka	A/B	Väre	20	90 (84)	1800-4200
Kirsikka	A/B	Valve	20	90 (84)	1800-4200
Douglaskuusi	A/B	Hohto	20	90 (84)	1800-4200
Douglaskuusi	A/B	Loisto	20	117 (111)	1800-4200
Douglaskuusi	A/B	Aalto	20	90 (84)	1800-4200
Douglaskuusi	A/B	Väre	20	90 (84)	1800-4200
Douglaskuusi	A/B	Valve	20	90 (84)	1800-4200

Rimapaneelit toimitetaan tilauksesta, toimitusaika 2-3 viikkoa

Rimapaneelit

Puulaji	Laatu	Profiili	Paksuus mm	Leveys mm	Pituus mm
Iroko	A/B	Hohto	20	90 (84)	1800-4200
Iroko	A/B	Loisto	20	117 (111)	1800-4200
Iroko	A/B	Aalto	20	90 (84)	1800-4200
Iroko	A/B	Väre	20	90 (84)	1800-4200
Iroko	A/B	Valve	20	90 (84)	1800-4200
Vaahtera	A/B	Hohto	20	90 (84)	1800-3000
Vaahtera	A/B	Loisto	20	117 (111)	1800-3000
Vaahtera	A/B	Aalto	20	90 (84)	1800-3000
Vaahtera	A/B	Väre	20	90 (84)	1800-3000
Vaahtera	A/B	Valve	20	90 (84)	1800-3000
Mänty lämp.käsit.	A/B	Hohto	20	90 (84)	1800-4200
Mänty lämp.käsit.	A/B	Loisto	20	117 (111)	1800-4200
Mänty lämp.käsit.	A/B	Aalto	20	90 (84)	1800-4200
Mänty lämp.käsit.	A/B	Väre	20	90 (84)	1800-4200
Mänty lämp.käsit.	A/B	Valve	20	90 (84)	1800-4200
Erikoismänty		Hohto	20	90 (84)	1800-4200
Erikoismänty	A/B	Loisto	20	117 (111)	1800-4200
Erikoismänty	A/B	Aalto	20	90 (84)	1800-4200
Erikoismänty	A/B	Väre	20	90 (84)	1800-4200
Erikoismänty	A/B	Valve	20	90 (84)	1800-4200

Rimapaneelit toimitetaan tilauksesta, toimitusaika 2-3 viikkoa



Akustiikka rimapaneelit

Puulaji	Laatu	Profiili	Paksuus mm	Leveys mm	Pituus mm
Tammi	A/B	Natur	30	600	2400/3000
Tammi	A/B	Walnut	30	600	2400/3000
Tammi	A/B	Black	30	600	2400/3000
Saarni	A/B	Natur	30	600	2400/3000
Saarni	A/B	Walnut	30	600	2400/3000
Saarni	A/B	Black	30	600	2400/3000
Vaahtera	A/B	Natur	30	600	2400/3000
Vaahtera	A/B	Walnut	30	600	2400/3000
Vaahtera	A/B	Black	30	600	2400/3000
Pähkinä	A/B	Natur	30	600	2400/3000
Pähkinä	A/B	Walnut	30	600	2400/3000
Pähkinä	A/B	Black	30	600	2400/3000

Akustiikka rimapaneelit toimitetaan tilauksesta, toimitusaika 2-3 viikkoa





Akustiikka rimapaneelit

Koot

- Leveys 60 cm
- Korkeus 240/300 cm
- Paksuus 3 cm
- Paino 15-20 kg



Rimat

21 x 43 mm
9 kpl/paneeli

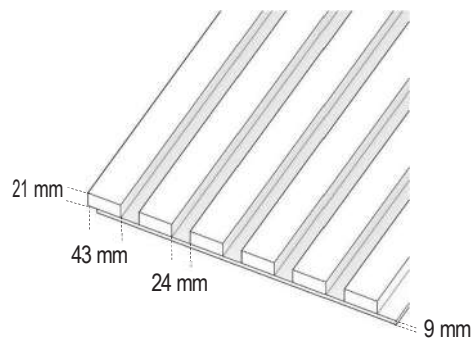

Sormijatkettu tammi, saarni, vaahtera.
3 väri vaihtoehtoa öljyttynä tai läpikuultava lakka.

Marron Wood Oy
Laatikkotehtaankatu 3 B
15240 LAHTI, FINLAND
www.marronwood.com

MARRONWOOD

Natural

Walnut

Black



Tausta:

- Kierrätetty PET
pehmeä muovi
- Vahvuus 9 mm

Asennus:

- Ruuvit
- Liima

Rustic paneeli

Puulaji	Laatu	Profiili	Paksuus mm	Leveys mm	Pituus mm
Tammi	Rustic	Holvi	20	160	2150-4200
Tammi	Rustic	Holvi	20	200	2150-4200
Tammi	Rustic	Holvi	20	260	2150-4200
Tammi	Rustic	Holvi	20	300	2150-4200
Pyökki	Rustic	Holvi	20	160	2400-3000
Pyökki	Rustic	Holvi	20	200	2400-3000
Pyökki	Rustic	Holvi	20	260	2400-3000

Rustic paneelit toimitetaan tilauksesta, toimitusaika 2-3 viikkoa





Saunapaneelit

Puulaji	Laatu	Profiili	Paksuus mm	Leveys mm	Pituus mm
Thermo Royal	A/B	Aava	18	90	1800-3000
Thermo Royal	A/B	Aava	18	140	1800-3000
Thermo Royal	A/B	Aava	18	190	1800-3000
Thermo Royal	A/B	Aava	18	300	1800-3000
Thermo Royal	A/B	Valve	20	90	1800-3000
Thermo Royal	A/B	Valve	20	140	1800-3000
Thermo Royal	A/B	Aro	18	90	1800-3000
Thermo Royal	A/B	Aro	18	140	1800-3000
Thermo Royal	A/B	Halla	25	90	1800-3000
Thermo Royal	A/B	Halla	25	140	1800-3000
Thermo Royal	A/B	Hohto	20	90	1800-3000
Thermo Royal	A/B	Väre	20	90	1800-3000
Thermo Royal	A/B	Loisto	20	90	1800-3000
Abachi , valkoinen	A/B	Aava	18	90	1800-3000
Abachi , valkoinen	A/B	Aava	18	140	1800-3000
Abachi , valkoinen	A/B	Aava	18	190	1800-3000
Abachi , valkoinen	A/B	Valve	20	90	1800-3000
Abachi , valkoinen	A/B	Valve	20	140	1800-3000
Abachi , valkoinen	A/B	Aro	18	90	1800-3000
Abachi , valkoinen	A/B	Aro	18	140	1800-3000
Abachi , valkoinen	A/B	Halla	25	90	1800-3000
Abachi , valkoinen	A/B	Halla	25	140	1800-3000
Abachi , valkoinen	A/B	Hohto	20	90	1800-3000
Abachi , valkoinen	A/B	Väre	20	90	1800-3000
Abachi , valkoinen	A/B	Loisto	20	117	1800-3000
Abachi , valkoinen	A/B	Aalto	20	90	1800-3000
Kirsikka	A/B	Aava	18	90	1800-3000
Kirsikka	A/B	Aava	18	120	1800-3000
Kirsikka	A/B	Aava	18	140	1800-3000
Kirsikka	A/B	Aava	18	190	1800-3000
Kirsikka	A/B	Valve	20	90	1800-3000
Kirsikka	A/B	Valve	20	140	1800-3000
Kirsikka	A/B	Aro	18	90	1800-3000
Kirsikka	A/B	Aro	18	140	1800-3000
Kirsikka	A/B	Halla	25	90	1800-3000
Kirsikka	A/B	Halla	25	140	1800-3000

Saunapaneelit toimitetaan tilauksesta, toimitusaika 2-3 viikkoa

Saunapaneelit

Puulaji	Laatu	Profiili	Paksuus mm	Leveys mm	Pituus mm
Douglaskuusi	A/B	Aava	20	120	1800-4800
Douglaskuusi	A/B	Aava	20	140	1800-4800
Douglaskuusi	A/B	Aava	20	200	1800-4800
Douglaskuusi	A/B	Valve	20	90	1800-4800
Douglaskuusi	A/B	Valve	20	140	1800-4800
Douglaskuusi	A/B	Aro	18	90	1800-4800
Douglaskuusi	A/B	Aro	18	140	1800-4800
Douglaskuusi	A/B	Halla	25	90	1800-4800
Douglaskuusi	A/B	Halla	25	140	1800-4800
Douglaskuusi	A/B	Hohto	20	90	1800-4800
Douglaskuusi	A/B	Väre	20	90	1800-4800
Douglaskuusi	A/B	Loisto	20	117	1800-4800
Douglaskuusi	A/B	Aalto	20	90	1800-4800
Thermo mänty	A/B	Aava	20	90	1800-3000
Thermo mänty	A/B	Aava	20	140	1800-3000
Thermo mänty	A/B	Valve	20	90	1800-3000
Thermo mänty	A/B	Valve	20	140	1800-3000
Thermo mänty	A/B	Aro	18	90	1800-3000
Thermo mänty	A/B	Aro	18	140	1800-3000
Thermo mänty	A/B	Halla	25	90	1800-3000
Thermo mänty	A/B	Halla	25	140	1800-3000
Thermo mänty	A/B	Hohto	20	90	1800-3000
Thermo mänty	A/B	Väre	20	90	1800-3000
Thermo mänty	A/B	Loisto	20	117	1800-3000
Thermo mänty	A/B	Aalto	20	90	1800-3000

Saunapaneelit toimitetaan tilauksesta, toimitusaika 2-3 viikkoa



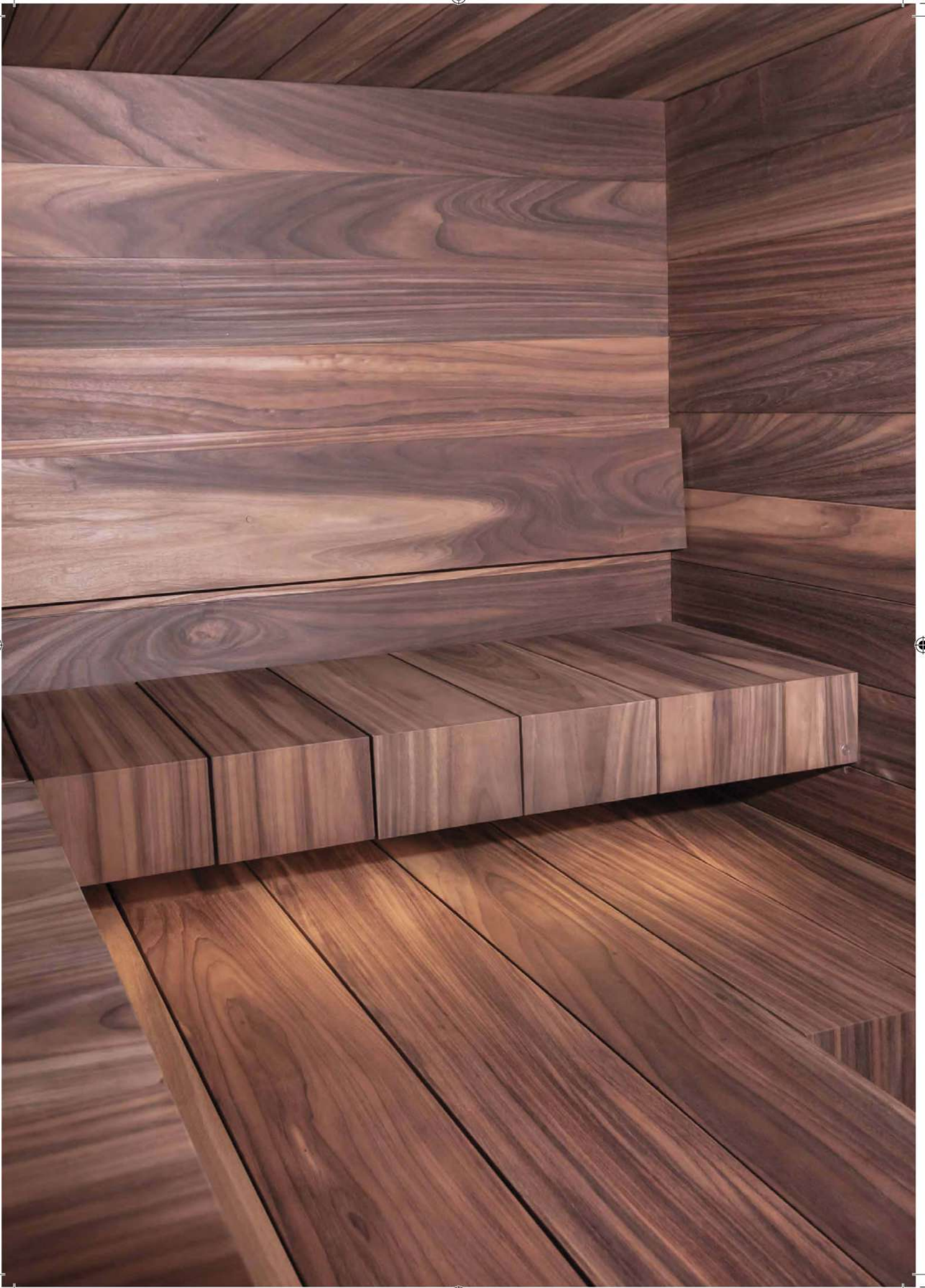

Saunalauteet

Puulaji	Laatu	Profiili	Paksuus mm	Leveys mm	Pituus mm
Thermo Royal	A/B	SHP	25	90	1550-4250
Thermo Royal	A/B	SHP	25	140	1550-4250
Thermo Royal	A/B	SHP	25	190	1550-4250
Thermo Royal	A/B	SHP	40	200	1550-4250
Thermo Royal	A/B	SHP	40	300	1550-4250
Thermo Royal	A/B	SHP	60	200	1550-4250
Thermo Royal	A/B	SHP	60	300	1550-4250
Abachi , valkoinen	A/B	SHP	25	95	1550-4250
Abachi , valkoinen	A/B	SHP	25	140	1550-4250
Abachi , valkoinen	A/B	SHP	25	190	1550-4250
Abachi , valkoinen	A/B	SHP	40	200	1550-4250
Abachi , valkoinen	A/B	SHP	40	300	1550-4250
Abachi , valkoinen	A/B	SHP	60	200	1550-4250
Abachi , valkoinen	A/B	SHP	60	300	1550-4250
*Kirsikka	A/B	SHP	28	90	1550-3000
*Kirsikka	A/B	SHP	28	140	1550-3000
*Kirsikka	A/B	SHP	28	190	1550-3000
*Kirsikka	A/B	SHP	40	140	1550-3000
*Kirsikka	A/B	SHP	40	200	1550-3000
*Douglaskuusi	A/B	SHP	28	90	1550-4800
*Douglaskuusi	A/B	SHP	28	140	1550-4800
*Douglaskuusi	A/B	SHP	28	190	1550-4800
*Douglaskuusi	A/B	SHP	28	340	1550-4800
*Douglaskuusi	A/B	SHP	40	200	1550-4800
*Douglaskuusi	A/B	SHP	40	300	1550-4800
*Thermo mänty	A/B	SHP	25	95	1550-3000
*Thermo mänty	A/B	SHP	25	140	1550-3000
*Thermo mänty	A/B	SHP	25	190	1550-3000
*Thermo mänty	A/B	SHP	40	140	1550-3000
*Thermo mänty	A/B	SHP	40	190	1550-3000

* Saunalauteet toimitetaan tilauksesta, toimitusaika 2-3 viikkoa



Terassilaudat ja tammiparrut

Puulaji	Laatu	Profiili	Paksuus mm	Leveys mm	Pituus mm
Eukalyptus	A/B	Prime	27	120	Eri pit.
Eukalyptus	A/B	Prime	27	145	Eri pit.
Iroko	A/B	Prime	27	120	Eri pit.
Iroko	A/B	Prime	27	145	Eri pit.
Jatoba	A/B	Prime	27	120	Eri pit.
Jatoba	A/B	Prime	27	145	Eri pit.
Padauk	A/B	Prime	27	120	Eri pit.
Padauk	A/B	Prime	27	145	Eri pit.
Sucupira	A/B	Prime	27	120	Eri pit.
Sucupira	A/B	Prime	27	145	Eri pit.

Terassilaudat toimitetaan tilauksesta, toimitusaika 2-3 viikkoa

Tammiparru	Rustic		100	100	Eri pit.
*Tammiparru	Rustic		150	150	Eri pit.
*Tammiparru	Rustic		300	300	Eri pit.
*Tammiparru	Rustic		400	400	Eri pit.
*Tammiparru	Rustic		370	370	550 mm.

* Tammiparrut toimitetaan tilauksesta, toimitusaika 2-3 viikkoa





Mikko Avikainen
0401868586

Juha Suninen
0505002528

Jarmo Aalto
0401375959

